

Compare

Belt Cleaner Component Comparisons

All solid-blade precleaners are not the same. Traditionally, many have viewed these precleaners as "all about the same" because they look similar. So aside from color, the only consideration was the price. However, a review and comparison of the cleaner components reveals that there **are** many differences. And these differences have a big impact on cleaner performance, durability, and maintenance costs.

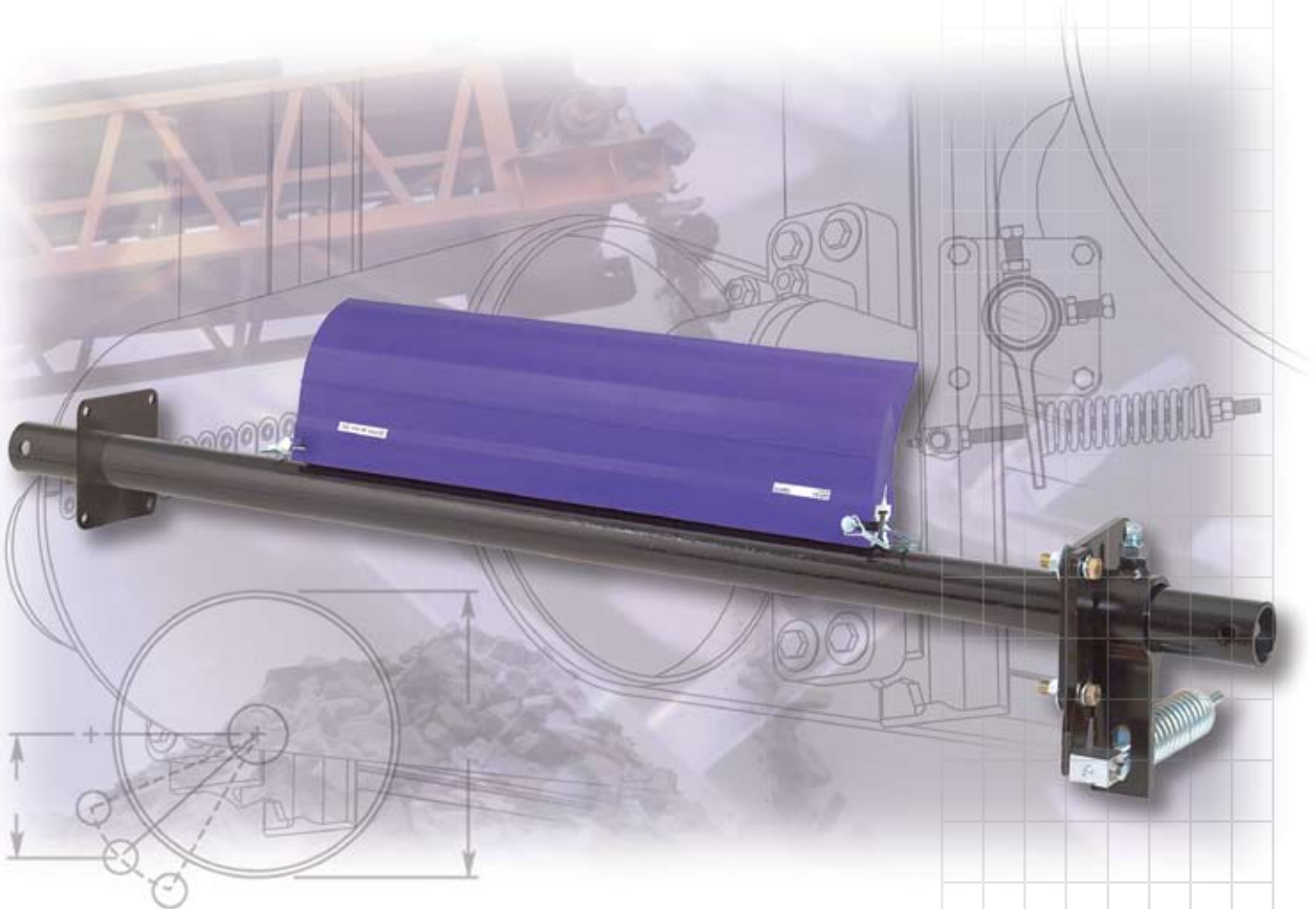

The Facts

Examine the facts....

FLEXCO

POLES

The Precleaner Pole

1. Pole Strength

Cleaner Type	O.D. by tape measure	Wall thickness	Moment of Inertia*
Martin® QC™ #1	1-7/8"	0.281	0.48
Martin® Pit Viper™	1-7/8"	0.200	0.39
Arch/Gordon Saber®	1-7/8"	0.200	0.39
ASGCO® Skalper® IV	1-7/8"	0.281	0.48
Rockline® EZP1	2-3/8"	0.218	0.87

* Moment of Inertia is an engineering calculation of a pole's cross-section strength.

Pole Cross-Sections

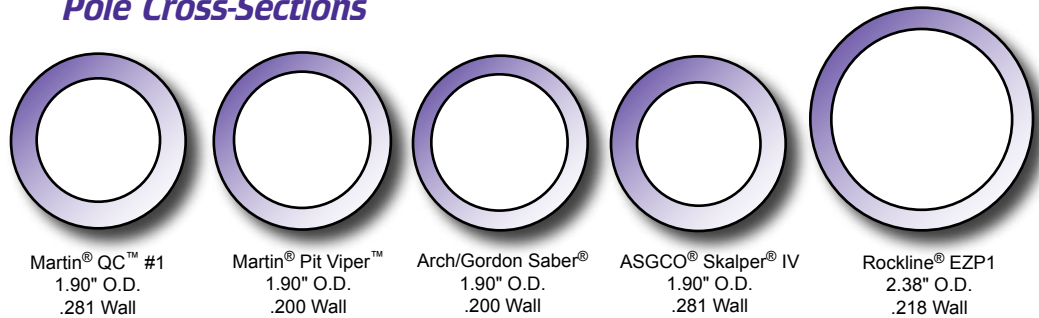

All pole sizes shown at 1/2 scale.

Overall Strength

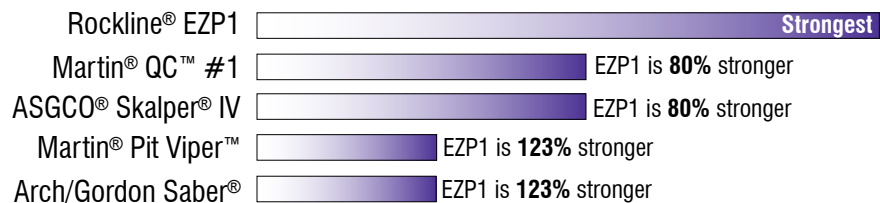

Benefits of a Stronger Pole

- Assures the blade is held at the correct position even under heavy loads.
- Better resistance to bending.
- More durable.
- No pole twisting when the blade is tensioned from one side, so blade-to-belt tension is consistent across the width of the belt.

POLES

2. Pole Location

Benefits of Correct Pole Location:

- Permits correct blade attack angle (See Fig. 1).
- Allows maximum cleaning performance.
- Ensures maximum blade life. Entire wear area of blade can be used.

Problems caused by incorrect Pole Location

Pole too far out:

- Incorrect blade attack angle. At installation, just the tip of the blade is on the belt (See Fig. 2).
- Blade wears faster. More prominent "smile" wear effect.
- Requires more blade tensioning maintenance.
- Blade is more likely to "flip under". Possible damage to blade and pole.
- More mechanical splice impact (hooking).

Pole too close:

- Incorrect blade attack angle. At installation, tip of the blade may not touch belt (See Fig. 3).
- Poor cleanability.
- May wear a "flap" on the blade.
- Carryback material getting past the tip will wear the blade quickly.
- Can get pushed away from the belt due to material buildup between the blade and the belt.

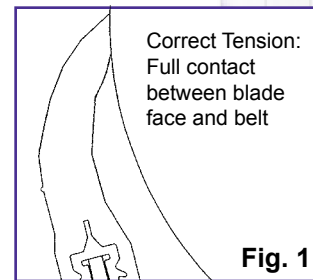

Correct pole location

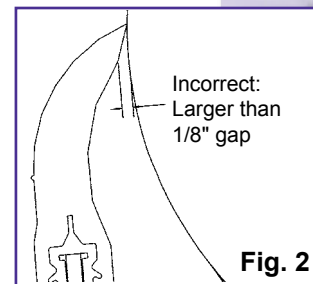

Pole too far out

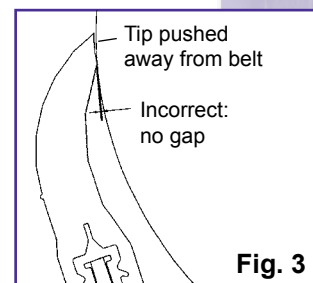

Pole too close

CORRECT POLE LOCATION ALLOWS
MAXIMUM PERFORMANCE

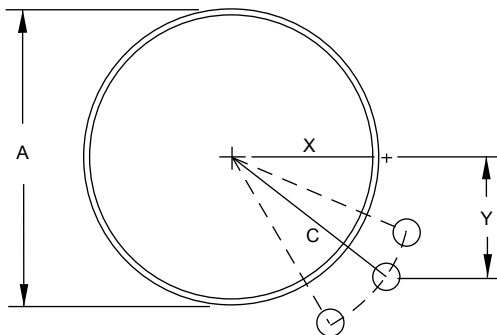

- A = Pulley Diameter + Lagging and Belt
- C = Critical dimension to maintain the best performance
- X&Y = Measurement to determine pole location in relation to head pulley

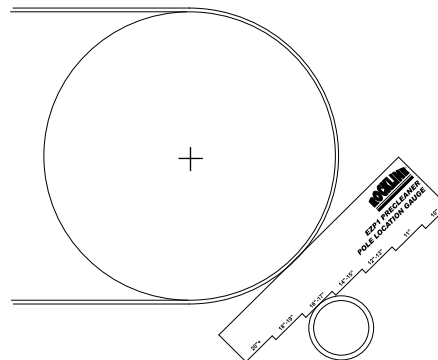

All Rockline® EZP1 Precleaners come with an easy-to-use gauge to check for correct pole location.

BLADES

The Blade

1. Blade Life

- All urethanes are NOT the same. Urethane technology continues to advance and so do blades.
- Errors made in blade molding affect the quality and performance.
- ConShear's proprietary formula is more advanced and outperforms other urethanes in various applications.

A proprietary formulation means a better performing urethane.

To evaluate the wear characteristics of various urethanes, we subjected the material used in ConShear™ blades, as well as the materials used in other OEM blades, to standard ASTM tribology testing procedures at a third-party testing lab.

This chart shows comparative test results for the material in ConShear, as well as sample materials currently used by other manufacturers. Actual grams lost during testing are expressed as a percentage.

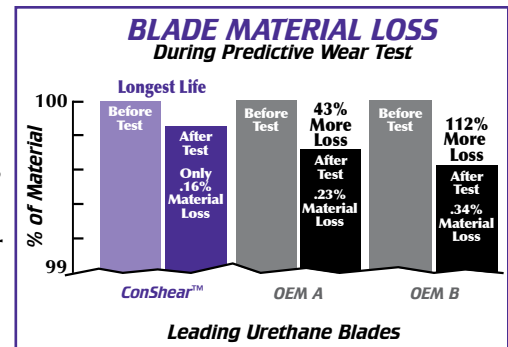

2. Blade Volume (of useable urethane)

Many contend that more urethane in a cleaner blade means more blade life. Volume is a part of the story. But the urethane must also have abrasion resistance. So the complete formula for a long-wearing blade is:

BLADE LIFE = VOLUME x WEAR RESISTANCE

Cleaner Type	Blade Length	Useable Blade Area (cross-section)	Useable Blade Volume
Martin® QC™ #1	28"	3.00 in ²	84.0 in ³
Martin® Pit Viper™	28"	4.20 in ²	117.6 in ³
Arch/Gordon Saber®	28"	3.06 in ²	85.7 in ³
ASGCO® Skalper® IV	28"	3.29 in ²	92.1 in ³
Rockline® EZP1	28"	5.50 in ²	154.0 in ³

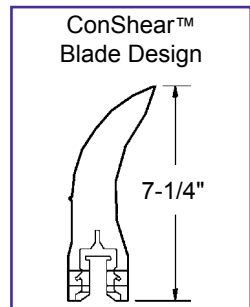
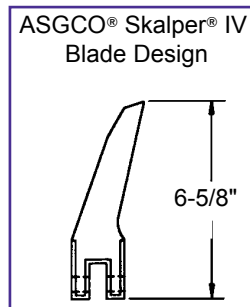
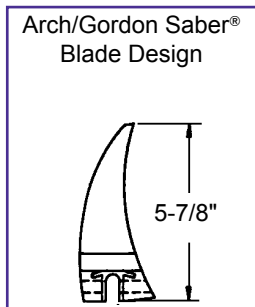
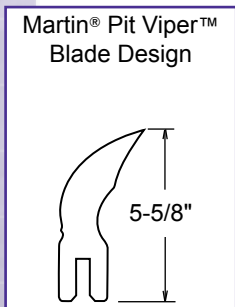
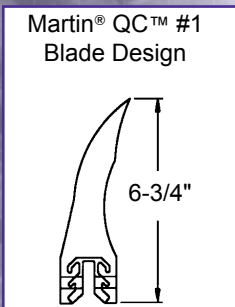

BLADES

3. Attack Angle on Belt

The angle at which the blade touches the belt is critical for performance. The attack angle is determined or can be influenced by: 1) the shape of the blade, and 2) the location of the cleaner pole at installation.

- If the angle is too blunt - the blade will do a poor cleaning job and will not "peel off" the carryback material.
- If the angle is too sharp or aggressive - the blade will create a hard impact with mechanical splices, which can lead to blade or splice damage. It may also wear a "flap" on the blade tip, reducing cleaning effectiveness.
- ConShear blades have found the "sweet spot" attack angle to the belt. This provides optimal cleaning efficiency, as well as complete compatibility with mechanical splices.

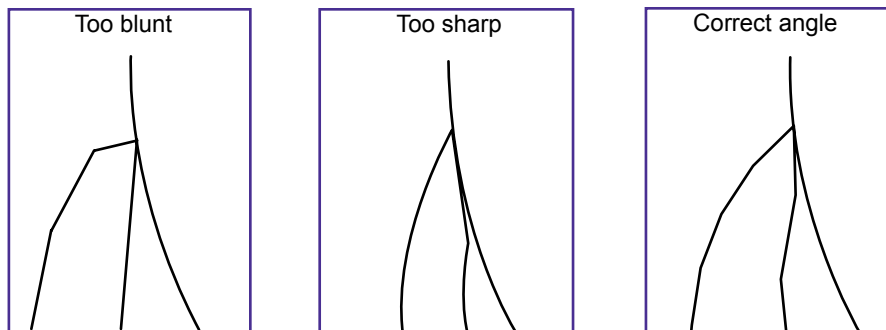

4. Material Path Option

For optimal cleaning and reduced blade retensioning, the cleaner blade width should be sized to fit the material path of the belt. The material path is typically the center 2/3 of the belt width. Choosing a blade only slightly wider than the material path can decrease differential blade wear, which reduces blade retensioning maintenance as well as reducing the frequency of blade replacement.

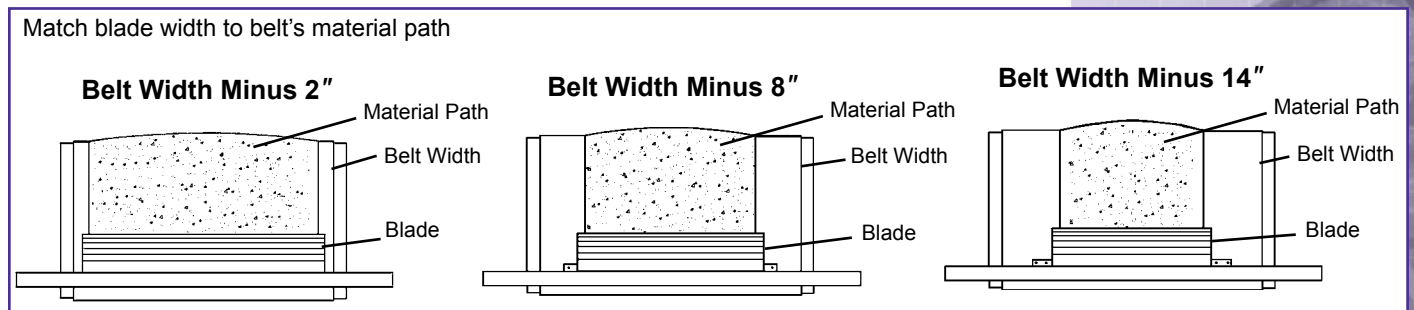

Each Rockline EZP1 precleaner size can be modified to the belt's material path with belt width minus 2", minus 8" or minus 14" blade options. And if the material path changes, the blade can be changed without modifying the cleaner.

TENSIONERS

The Tensioning Unit

Benefits of Proper Tensioning:

- Maximum cleanability
- Consistent performance
- Longer blade life
- Easier maintenance

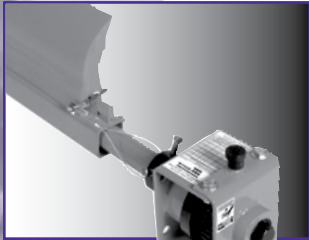

Martin® QC™ #1:

- Twist Tensioner - rubber element
- Setup Instructions - ratchet the spindle a specified number of notches (per belt width) and lock
- No instructions on retensioning maintenance or inspection
- Can't measure tension

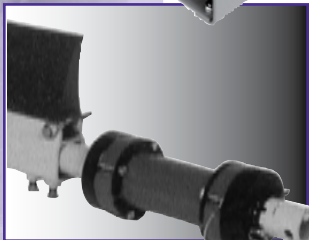

Arch/Gordon Saber®:

- Gordon Twister - urethane tube
- Tube takes a set
- Subject to environmental conditions
- Can't measure tension
- Must back tension off to add tension

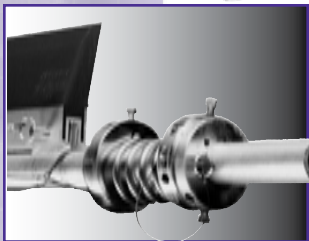

ASGCO® Skalper® IV:

- E-Z Torque - self-contained spring
- Spring doesn't take a set
- Can't measure tension
- Must back tension off to add tension



Rockline® EZPI:

- EST Tensioner - self-contained compression spring
- Easy to install
- Visual tension check
- Easy tension adjustment
- Spring doesn't take a set



Flexible Steel Lacing Company
 2525 Wisconsin Avenue
 Downers Grove, IL 60515-4200 U.S.A.
 Telephone: (630)-971-0150
 Fax: (630)-971-1180
 BCP Help Line: 1-800-253-8132
 E-mail: info@flexco.com



Tensioner Type	Easy to install and set up	Can visually check tension	Easy to add more tension	Easy to reset at optimal tension	Tension element doesn't take a set
Rockline® EST	yes	yes	yes	yes	yes
Martin® Twist™ Tensioner	yes	no	yes	no	no
ASGCO® E-Z Torque®	no	no	no	no	yes
Arch/Gordon Twister	no	no	no	no	no

www.flexco.com

Australia: 61-2-9680-3322 • England: 44-1274-600-942 • Germany: 49-7428-9406-0 • Mexico: 52 55 56-74-53-26 • Republic of South Africa: 27-11-608-4180

©2007 Flexible Steel Lacing Company. Rockline® is a registered trademark and ConShear™ is a trademark of Flexible Steel Lacing Company. Released 3/07. For Reorder: Item Code X1501

Martin® is a registered trademark, and QC™, Pit Viper™ and Twist™ are trademarks of Martin Engineering, Neponset, IL. ASGCO®, Skalper® and E-Z Torque® are registered trademarks of ASGCO Mfg, Inc., Allentown, PA.

Saber® is a registered trademark of Arch Environmental Equipment, Inc., Paducah, KY.